

oransi

OWNER'S MANUAL

Finn Air Purifier

Model No.: OVHT9908

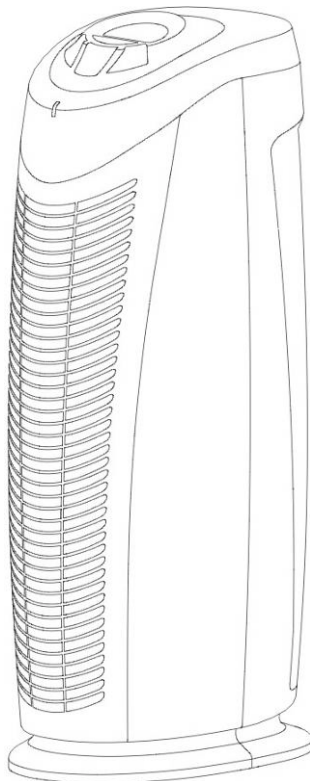

TABLE OF CONTENTS

IMPORTANT SAFEGUARDS	1
MAIN PARTS	2
OPERATION	3
PRE-OPERATING INSTRUCTIONS	
OPERATING INSTRUCTIONS	
CLEANING AND MAINTENANCE	5
CLEANING PRE-FILTER.....	5
CLEANING HEPA FILTER.....	6
REMOVING/INSTALLING UV LAMP.....	8
CLEANING AND MAINTENANCE.....	11
TROUBLE-SHOOTING	11

READ ALL INSTRUCTIONS BEFORE USING THIS APPLIANCE.

WARNING: RISK OF ELECTRICAL SHOCK

- Safety precautions should always be used when operating this or any electrical appliance.
- Decrease the risk of electrocution, electric shock, injury or fire by reading and following all of the warnings below.
- To reduce the risk of electric shock, do not attempt to service the air purifier in any way other than to replace or clean the air filter.
- Read all instructions before operating the air purifier.
- This product operates at 120V AC, 60Hz only.
- Do not run the power cord under carpets, and do not cover with throw rugs.
- This product is not intended to filter oil or grease from air.
- Always unplug the power cord from the electrical outlet when the air purifier is not in use or when changing the filter.
- Never run the air purifier unless it is fully assembled.
- Do not alter the plug in any way.
- Always turn off the air purifier before unplugging the air purifier from outlet.
- Do not place the cord near a heated surface.
- Never operate the air purifier if the plug or cord is damaged or appears damaged. Only qualified service personnel should ever replace or attempt to replace a damaged power cord.
- Never use the power cord to pick up, carry, drag, pull, or lift the air purifier. Do not pull the cord against or around sharp corners and edges.
- Always remove the plug from its power outlet by holding onto the plug itself and pulling gently.
- Never pull on the cord itself to unplug it from its power outlet.
- Use care when operating the air purifier by keeping all foreign objects, fingers, body parts, hair, loose clothing and jewelry away from openings.
- Never touch the air purifier or its plug when your hands are wet.

Note:

Before operating the air purifier, make sure the air filters inside the air purifier are not wrapped in plastic. When the air purifier is plugged in you should hear a beep. Press the Power button to turn it on. If the air purifier does not power on, ensure the front cover is installed correctly.

Save these instructions!

MAIN PARTS

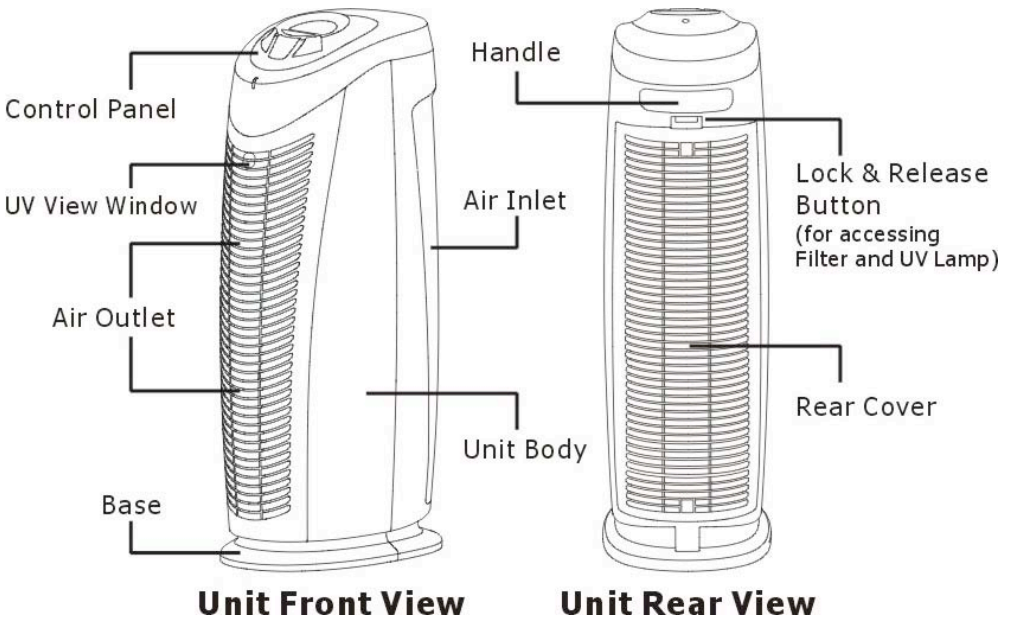

OPERATION

PRE-OPERATING INSTRUCTIONS

1. Carefully remove your air purifier from the gift box and the bag.
2. Remove the back cover and remove the filter from the bag.
3. Select a firm level and flat location. For proper air flow, locate the unit at least 1 foot (0.3 M) from any wall or furniture. Ensure no grilles are blocked.
4. Plug the power cord into a **120V AC** outlet.

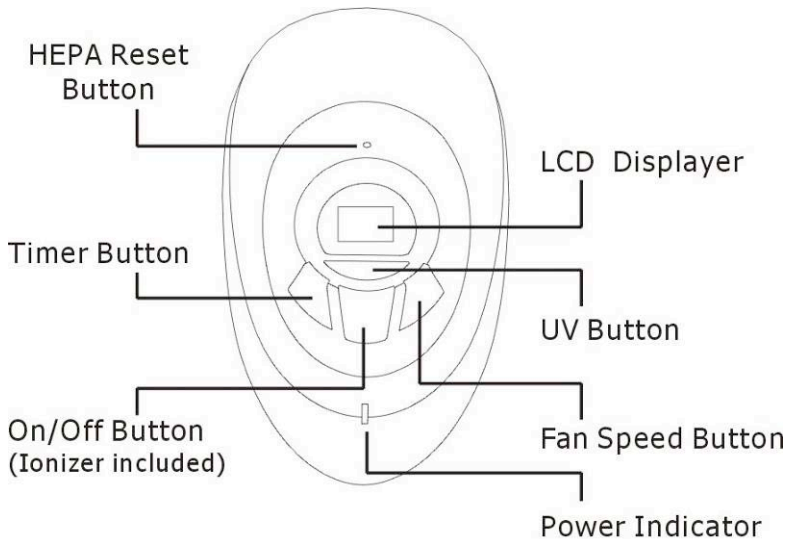







Unit Top View



OPERATING INSTRUCTIONS

The air purifier is operated by the manual controls located on the top of air purifier (as shown in **Unit Top View**).



1. Plug the air purifier into a **120V AC** outlet
2. Turn the air purifier on by pressing **On/Off Button** (ⓘ).
3. Upon turning the air purifier on, the power indicator will be lit, the unit will be in the **High** fan speed (🌀3), and the ionizer will start to work.

4. Pressing **Fan Speed Button** () at this point will set the air purifier into **Medium** fan speed ().
5. Pressing **Fan Speed Button** () again will set the air purifier into **Low** fan speed ().
6. Pressing **Fan Speed Button** () once more will set the air purifier back to **High** fan speed ().
7. To turn the air purifier off, press the **On/Off Button** ().

COUNT DOWN TIMER FUNCTION:

The count down timer function allows you to set the length of operation from 1 hour (**1H**) to 8 hours (**8H**) and then the unit will power off. Press the **Timer Button** () to set your desired operation time. Once the timer has been set, the timer icon will light on the LCD display and the timer will count down the hours, until the air purifier will turn itself off. Pressing **Timer Button** () once more after the timer icon reflects 8 hours (**8H**) will reset the air purifier to continuous running.

UV LAMP FUNCTION:

The UV-C germicidal lamp can kill harmful airborne bacteria and virus. This function will work in any mode. Press the **UV Button** () to start the UV lamp and stop the UV lamp by pressing the **UV Button** () again.

UV LAMP RESET FUNCTION:

If the UV lamp needs to be replaced, the UV icon on the LCD will illuminate and flicker. After replacing the UV lamp, reset the UV lamp by pressing the **UV Button** () for a few seconds, the UV icon will stop flickering and the new UV lamp will start to work. Check from the UV view window (Unit Front View in page 2), if the UV lamp still lights, it should not be replaced.

HEPA RESET FUNCTION:

If the HEPA filter needs to be cleaned, HEPA Reset icon on LCD will illuminate and flicker. After cleaning the HEPA filter, RESET the HEPA filter by using a pin or needle to press the **HEPA RESET Button** () , then the icon will stop flickering. For instructions on how to clean the HEPA filter see the **CLEANING HEPA FILTER** on page 6.

CLEANING AND MAINTENANCE

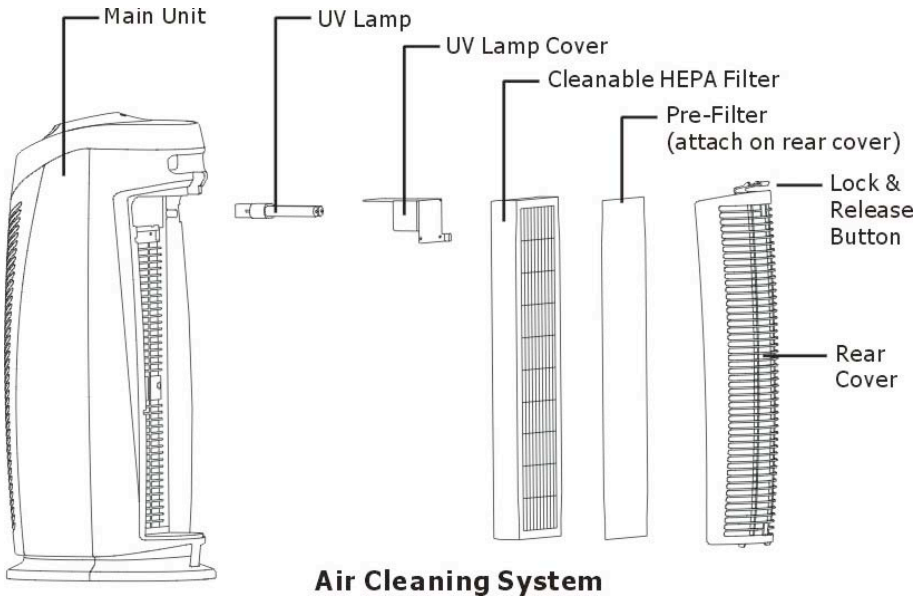

CLEANING PRE-FILTER (See Air Cleaning System)

1. Turn off and unplug the unit;
2. Press the Lock & Release Button and remove the Rear Cover from the unit;

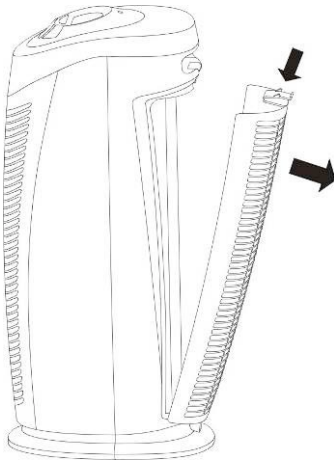

NOTE: The unit will shut off after the rear cover is removed.

3. Remove the pre-filter from the rear cover. Clean the pre-filter with the vacuum brush attachment of your vacuum cleaner. This will remove lint and dirt from the filter. Use a clean, damp, soft cloth to wipe the pre-filter again.

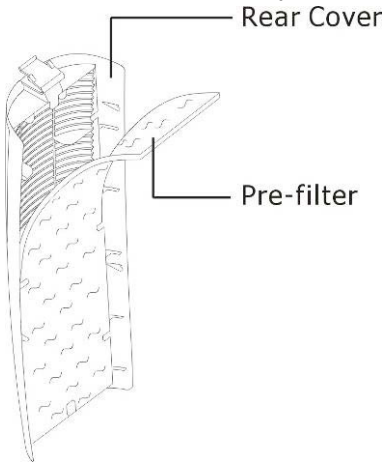

NOTE: Clean the pre-filter often if possible.

4. After cleaning, reattach the pre-filter to the rear cover, and install the rear cover back to unit and securely latch in place.

CLEANING HEPA FILTER (See Air Cleaning System)

1. Turn off and unplug the unit;
2. Press the Lock & Release Button and remove the Rear Cover from the unit;

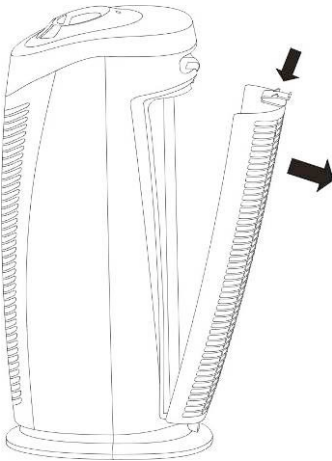

NOTE: The unit will shut off after the rear cover is removed.

3. Remove the HEPA filter.

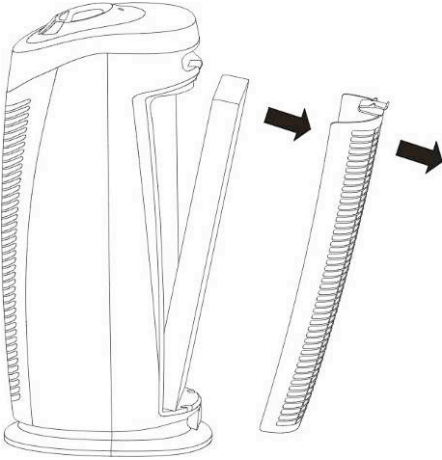

4. Use the brush attachment with your vacuum cleaner to clean the filter.

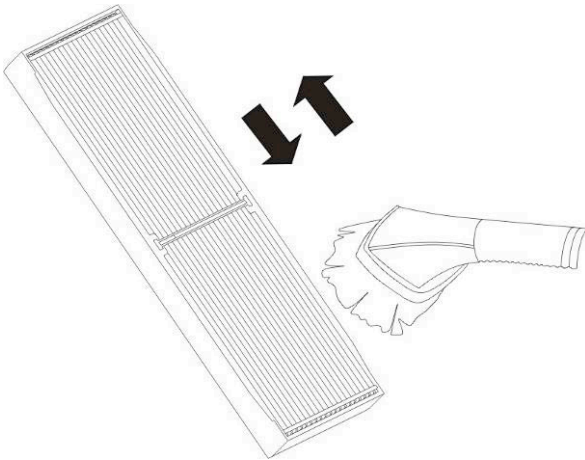

CAUTION: Do not use water or any household cleaner to clean the HEPA filter.

NOTE: The HEPA filter can be used continuously for up to two years. When the HEPA filter turns from white to black, it should be replaced with a new one. If the HEPA filter is still white, it does NOT need to be replaced.

5. Depending upon your filter type, either it will only fit in one way or reference the arrow on the side of the filter. Install the rear cover back to unit and securely latch in place.

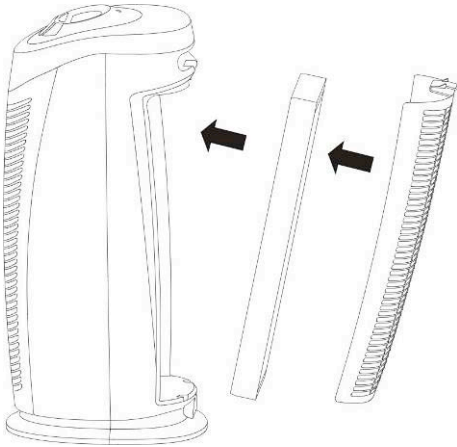

NOTE: Both of filter and rear cover must be installed otherwise the purifier will not power on.

REMOVING/INSTALLING UV LAMP (See Air Cleaning System)

1. Turn off and unplug the unit.
2. Press the Lock & Release Button and remove the Rear Cover from the unit.

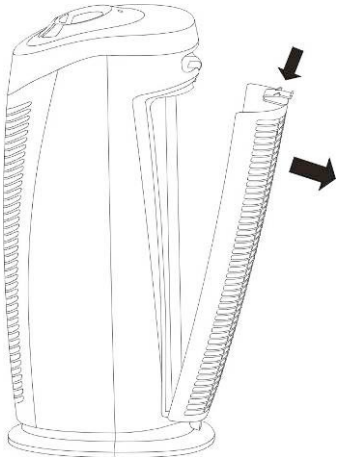

NOTE: The unit will shut off after the rear cover is removed.

3. Remove the HEPA filter.

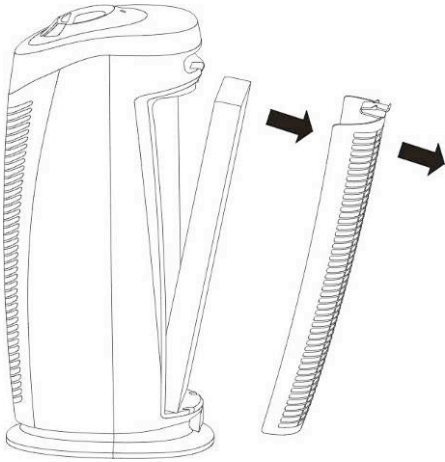

4. Use a screwdriver to remove the two screws and detach the UV lamp cover.

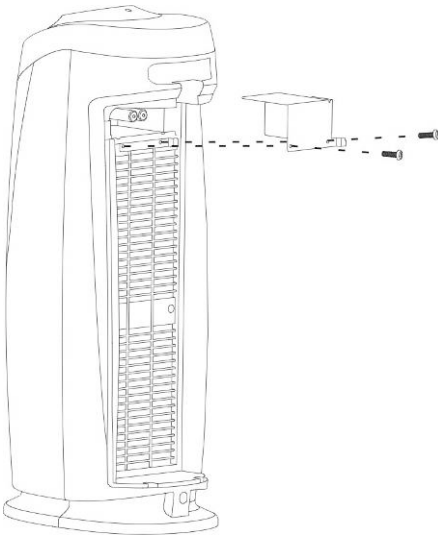

5. Grasp the UV lamp and pull it straight out from the lamp socket. The lamp is made of quartz so it is stronger than a standard UV lamp however we recommend reaching in toward the base since it is easier to remove from here than pulling on the end of the lamp. If you have rubber gloves or something similar that has a non-slip grip that is preferred. You should minimize the contact time with your fingers on the glass.

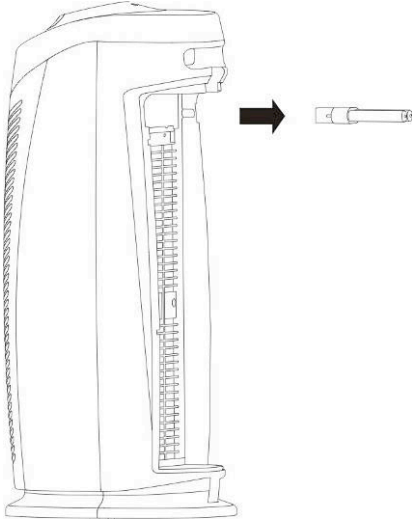

CAUTION: UV lamp is a glass product, please handle it carefully. Please reference www.oransi.com for more information including a video demonstration that shows how to replace the UV lamp.

6. Take a new UV lamp and insert it into the lamp socket. Simply press in on the end of the glass lamp to snap into place. Re-install the UV lamp cover (the large metal face should be above the uv lamp and align the two screw holes with the back of the air purifier), then install the filter and rear cover.

CLEANING AND MAINTENANCE

1. The air purifier should be checked at least once every month. More frequent cleaning may be required depending upon environmental conditions.
2. Clean the HEPA filter and pre-filter with the vacuum brush attachment of your vacuum cleaner. This will remove lint and dirt. See **CLEANING PRE-FILTER** and **CLEANING HEPA FILTER** on page 5 to 6.
3. Check the UV lamp from the UV view window (Unit Front View in page 2). If the UV lamp needs to be replaced, see **REMOVING/INSTALLING UV LAMP** on page 8.
4. Use a clean, dry, soft cloth to wipe the external surface of unit.

NOTE: Do not stick any foreign objects or your fingers inside the unit.

CAUTION: Do not use any chemical or harsh cleaners, etc., as they will damage the product. NEVER use ALCOHOL OR SOLVENTS.

TROUBLE SHOOTING TIPS

If the air purifier shuts off unexpectedly, safety features may have been activated to prevent damage or injury. If this happens:

1. Be sure the air purifier is plugged into a working electrical outlet;
2. Check to be sure the UV lamp and UV lamp cover are firmly seated in place;
3. Check to be sure the HEPA filter is firmly seated in place;
4. Check to be sure the rear cover is latched firmly in place.

NOTE: IF YOU CONTINUE TO EXPERIENCE A PROBLEM, PLEASE RETURN THE AIR PURIFIER TO THE PLACE OF ORIGINAL PURCHASE OR SEE YOUR WARRANTY. **DO NOT ATTEMPT TO TAKE APART THE UNIT BY YOURSELF.** DOING SO MAY VOID YOUR WARRANTY AND CAUSE DAMAGE TO THE PRODUCT OR PERSONAL INJURY.

